

TSKコンパクトサイズ転造ボールネジ TSK Compact Rolled Ball Screws

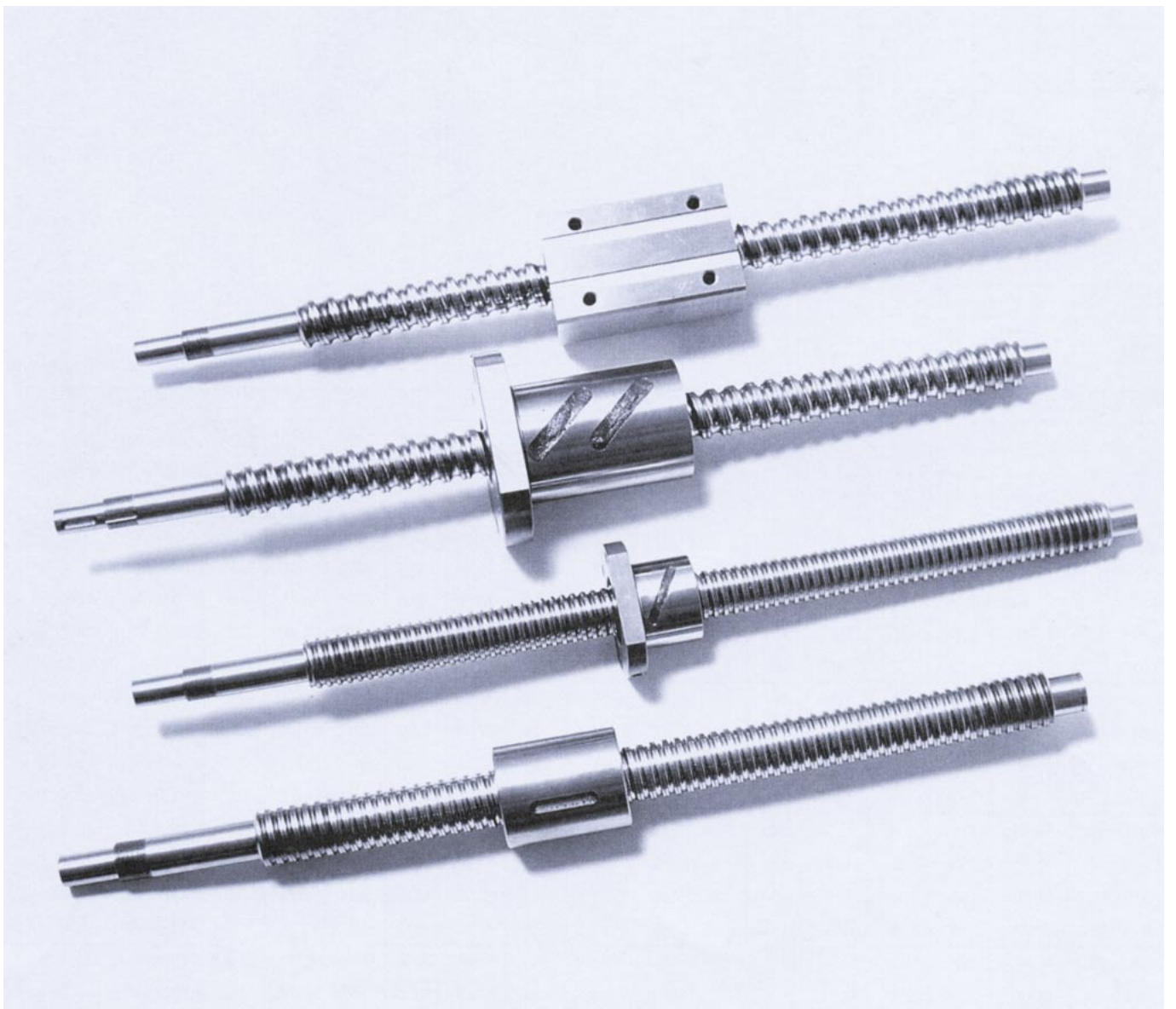



▶ 特 長

JIS B1192に基づき精度等級C10にて標準化しています。
 ナット両端にブラシワイパーを内蔵しています。
 リターンチューブ部に当社独自開発による特殊加工をしており、従来の
 ナットに比べ高速回転での振動音が低いです。
 ねじ軸とナットの標準化・量産により低価格、短納期対応が可能です。
 リターンチューブをナットに埋めこんだコンパクトサイズの為省スペース
 化が可能です。

Features:

TSK Compact Rolled Ball Screws with the built-in wiper brushes in the nut at both ends are standardized on C10 of the accuracy grade in accordance with JIS B1191. TSK has developed innovative machining performed on the return tube which makes the lowest vibration noise possible at high-speed rotary in comparison with conventional nuts. By standardizing and mass-producing shafts and nuts, TSK provides low prices and the shortest delivery possible. And the compact sized nut inserted in its return tube makes space saving possible

▶ 材質と熱処理 Materials and Heat Treatment

	材 質 Materials	熱 処 理 Heat Treatment	硬 度 Hardness
ネジ軸 Screw Shaft	SUJ2	高周波焼き入れ Induction Hardening	HRC56 ~ 62
ナット Nut	SCM415	浸炭焼入れ Carbonized Hardening	HRC58 ~ 62

▶ 軸径と呼びリード組合わせ Combination of Nominal Dia. and Nominal lead.

呼び外径 Nominal Dia.	呼びリード Nominal Lead				
	4	5	6	8	10
14					
16					
18					
20					
25					
28					
32					
36					

TSKコンパクトサイズ転造ボールネジ RBSKシリーズ Compact Rolled Ball Screws RBSK Series



呼び型番	ねじ軸		リード	巻方向	鋼鉄径	有効巻数	軸方向すきま
	外径 D	谷底径 d1					
RBSK1404-3.6	14	11.5	4	右	2.778	3.6	0.10
RBSK1405-2.6	14	11.2	5	右	3.175	2.6	0.10
RBSK1605-2.6	16	13.4	5	右	3.175	2.6	0.10
RBSK1808-3.6	18	14.4	8	右	4.763	3.6	0.10
RBSK2005-2.6	20	17.2	5	右	3.175	2.6	0.10
RBSK2010-2.6	20	16.6	10	右	4.763	2.6	0.15
RBSK2505-2.6	25	22.2	5	右	3.175	2.6	0.10
RBSK2510-5.3	25	20.2	10	右	6.350	5.3	0.20
RBSK2806-2.6	28	25.7	6	右	3.175	2.6	0.10
RBSK2806-5.3	28	25.7	6	右	3.175	5.3	0.10
RBSK3210-2.6	32	27.1	10	右	6.350	2.6	0.20
RBSK3210-5.3	32	27.1	10	右	6.350	5.3	0.20
RBSK3610-2.6	36	30.5	10	右	6.350	2.6	0.17
RBSK3610-5.3	36	30.5	10	右	6.350	5.3	0.17

呼び型番 (Code Name)

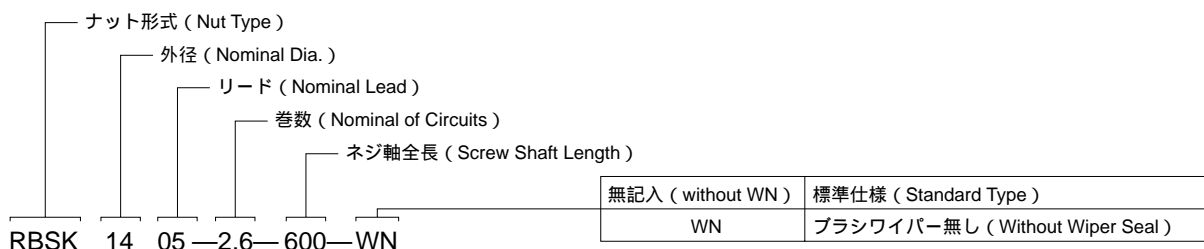

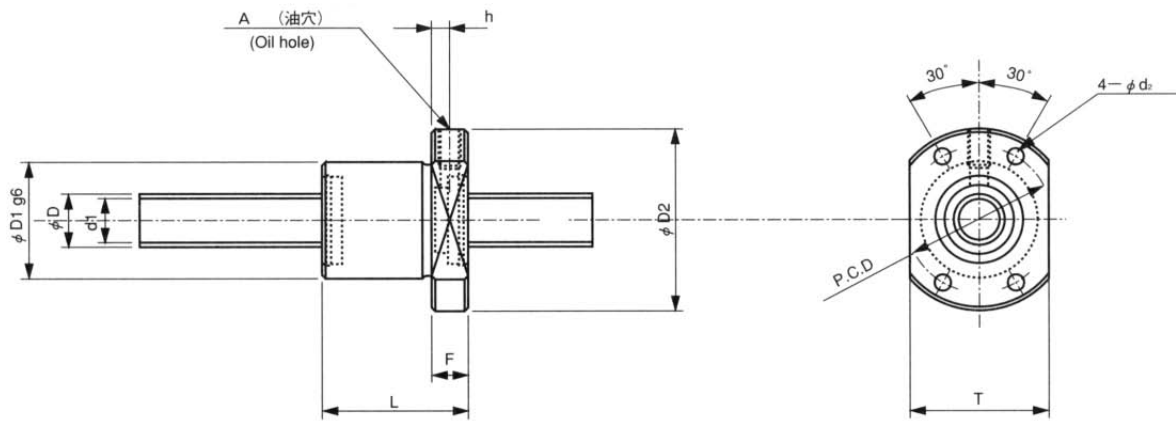

ナット寸法									基本定格荷重 kgf		標準軸長
外径 D1	全長 L	フランジ径 D2	F	P.C.D	d2	T	h	油穴 A	動定格 C	静定格 Co	
31	40	50	10	40	4.5	37	5	M6 × 1	560	1170	600
32	40	50	10	40	4.5	38	5	M6 × 1	510	1150	
34	40	54	10	44	4.5	40	5	M6 × 1	550	1350	
50	61	80	12	65	6.6	60	5	M6 × 1	1330	3160	1200
40	40	60	10	50	4.5	46	5	M6 × 1	610	1650	
52	61	82	12	67	6.6	64	5	M6 × 1	1080	2550	1000 1500 2000
43	40	67	10	55	5.5	50	5	M6 × 1	680	2100	
60	98	96	15	78	9.0	72	5	M6 × 1	3180	8500	
50	47	80	12	65	6.6	60	6	M6 × 1	710	2350	
50	65	80	12	65	6.6	60	6	M6 × 1	1300	4750	
67	68	103	15	85	9.0	78	5	M6 × 1	2010	5450	
67	97	103	15	85	9.0	78	5	M6 × 1	3670	10950	
70	70	110	17	90	11.0	62	7	M6 × 1	2120	6100	
70	100	110	17	90	11.0	62	7	M6 × 1	3850	12100	

TSKコンパクトサイズ転造ボールネジ RBSSシリーズ Compact Rolled Ball Screws RBSS Series



呼び型番	ねじ軸		リード	巻方向	鋼鉄径	有効巻数	軸方向すきま
	外径 D	谷底径 d1					
RBSS1404-3.6	14	11.5	4	右	2.778	3.6	0.10
RBSS1405-2.6	14	11.2	5	右	3.175	2.6	0.10
RBSS1605-2.6	16	13.4	5	右	3.175	2.6	0.10
RBSS1808-3.6	18	14.4	8	右	4.763	3.6	0.10
RBSS2005-2.6	20	17.2	5	右	3.175	2.6	0.10
RBSS2010-2.6	20	16.6	10	右	4.763	2.6	0.15
RBSS2505-2.6	25	22.2	5	右	3.175	2.6	0.10
RBSS2510-5.3	25	20.2	10	右	6.350	5.3	0.20
RBSS2806-2.6	28	25.7	6	右	3.175	2.6	0.10
RBSS2806-5.3	28	25.7	6	右	3.175	5.3	0.10
RBSS3210-2.6	32	27.1	10	右	6.350	2.6	0.20
RBSS3210-5.3	32	27.1	10	右	6.350	5.3	0.20
RBSS3610-2.6	36	30.5	10	右	6.350	2.6	0.17
RBSS3610-5.3	36	30.5	10	右	6.350	5.3	0.17

呼び型番 (Code Name)

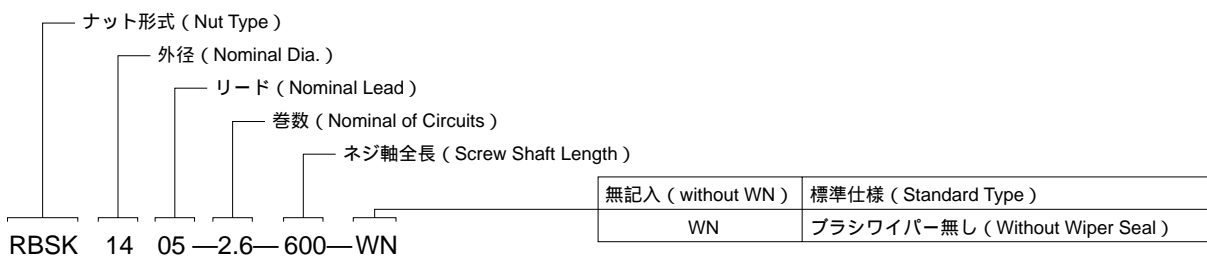

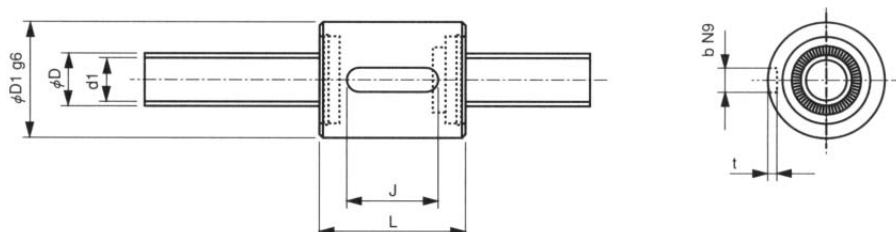

ナット寸法					基本定格荷重 kgf		標準軸長
D ¹	L	J	b	t	動定格 C	静定格 Co	
31	35	20	4	2.5	560	1170	600
32	36	20	4	2.5	510	1150	
34	36	20	5	3	550	1350	
50	56	32	6	3.5	1330	3160	1200
40	36	20	5	3	610	1650	
52	58	32	6	3.5	1080	2550	
43	36	20	5	3	680	2100	1000 1500 2000
60	94	50	8	4	3180	8500	
50	42	20	6	3.5	710	2350	
50	60	32	6	3.5	1300	4750	
67	64	32	8	4	2010	5450	
67	94	50	8	4	3670	10950	
70	64	32	8	4	2120	6100	
70	94	50	8	4	3850	12100	

TSKコンパクトサイズ転造ボールネジ角型ナット RBSCシリーズ Compact Rolled Ball Screws RBSC Series



呼び型番	ねじ軸		リード	巻方向	鋼鉄径	有効巻数	軸方向すきま
	外径 D	谷底径 d1					
RBSC1404-3.6	14	11.5	4	右	2.778	3.6	0.10
RBSC1405-2.6	14	11.2	5	右	3.175	2.6	0.10
RBSC1605-2.6	16	13.4	5	右	3.175	2.6	0.10
RBSC1808-3.6	18	14.4	8	右	4.763	3.6	0.10
RBSC2005-2.6	20	17.2	5	右	3.175	2.6	0.10
RBSC2010-2.6	20	16.6	10	右	4.763	2.6	0.15
RBSC2505-2.6	25	22.2	5	右	3.175	2.6	0.10
RBSC2510-5.3	25	20.2	10	右	6.350	5.3	0.20
RBSC2806-2.6	28	25.7	6	右	3.175	2.6	0.10
RBSC2806-5.3	28	25.7	6	右	3.175	5.3	0.10
RBSC3210-2.6	32	27.1	10	右	6.350	2.6	0.20
RBSC3210-5.3	32	27.1	10	右	6.350	5.3	0.20
RBSC3610-2.6	36	30.5	10	右	6.350	2.6	0.17
RBSC3610-5.3	36	30.5	10	右	6.350	5.3	0.17

呼び型番 (Code Name)

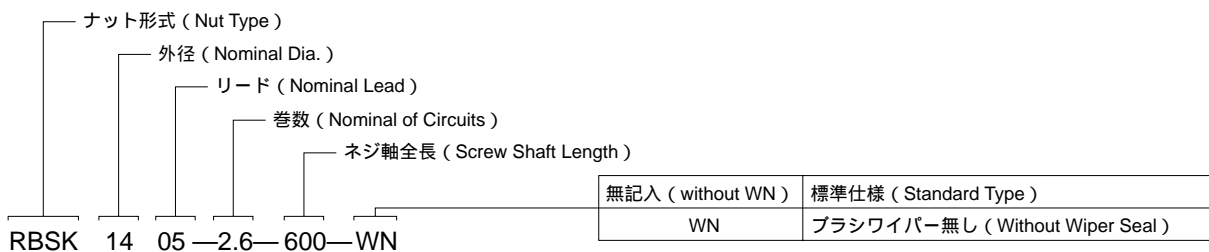

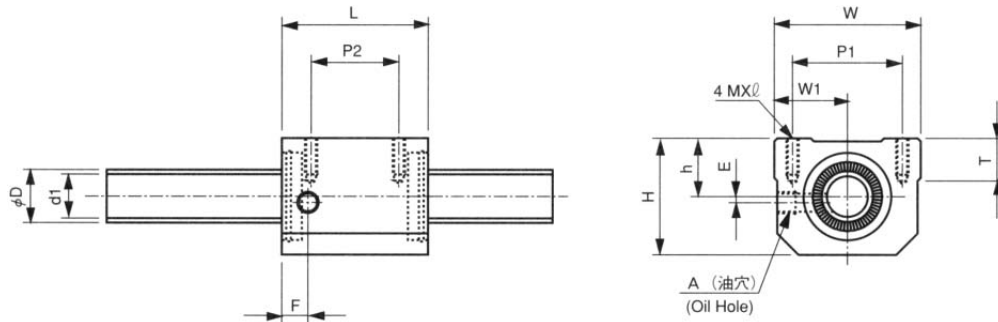

ナット寸法												基本定格荷重 kgf		標準軸長
幅 W	芯高 h	全長 L	P ₁	P ₂	M ×	W ₁	T	H	F	E	油穴 A	動定格 C	静定格 Co	
34	13	35	26	22	M4 × 5	17	6	30	6	2	M6 × 1	560	1170	600 1200
34	13	35	26	22	M4 × 5	17	6	31	6	2	M6 × 1	510	1150	
42	16	36	32	22	M5 × 8	21	6	33	6	2	M6 × 1	550	1350	
48	17	56	35	35	M6 × 10	24	10	44	8	3	M6 × 1	1330	3160	
48	17	35	35	22	M6 × 10	24	9	39	5	3	M6 × 1	610	1650	
48	18	58	35	35	M6 × 10	24	9	46	10	2	M6 × 1	1080	2550	
60	20	40	40	22	M8 × 8	30	9.5	45	7	5	M6 × 1	680	2100	1000 1500 2000
60	23	94	40	60	M8 × 12	30	10	53	10		M6 × 1	3180	8500	
60	22	42	40	18	M8 × 12	30	10	50	8		M6 × 1	710	2350	
60	22	67	40	40	M8 × 12	30	10	50	8		M6 × 1	1300	4750	
70	26	64	50	45	M8 × 12	35	12	62	10		M6 × 1	2010	5450	
70	26	94	50	60	M8 × 12	35	12	62	10		M6 × 1	3670	10950	
86	29	64	60	45	M10 × 16	43	17	67	11		M6 × 1	2120	6100	
86	29	96	60	60	M10 × 16	43	17	67	11		M6 × 1	3850	12100	